

373890..

MINI-SYSTEM
Unter 2 mm ein- und abstechen im System

MINI-SYSTEME
Système à rainurer et tronçonner en dessous de 2 mm

MINI-SYSTEM
Cut-Off and grooving system below 2 mm
Grooving inserts

Platten zum Einstechen *Plaquettes à rainurer*

Hartmetallsorte/nuance/grade	unbesch./non revêt./non coated			beschichtet/revêtue/coated			
Type/type	W[mm]	T	T[mm]	K10	P40	P25PV	P40PV
rechts/à dr/ right.	0.5	2.54	001	002	003	004	
links/à g./left	0.5	2.54	005	006	007	008	
rechts/à dr/ right.	0.7	2.54	009	010	011	012	
links/à g./left	0.7	2.54	013	014	015	016	
rechts/à dr/ right.	0.8	2.54	017	018	019	020	
links/à g./left	0.8	2.54	021	022	023	024	
rechts/à dr/ right.	0.9	2.54	025	026	027	028	
links/à g./left	0.9	2.54	029	030	031	032	
rechts/à dr/ right.	1.1	6	033	034	035	036	
links/à g./left	1.1	6	037	038	039	040	
rechts/à dr/ right.	1.3	6	041	042	043	044	
links/à g./left	1.3	6	045	046	047	048	
rechts/à dr/ right.	1.6	6	049	050	051	052	
links/à g./left	1.6	6	053	054	055	056	
rechts/à dr/ right.	1.85	6	057	058	059	060	
links/à g./left	1.85	6	061	062	063	064	
Preis/Stck./prix/price/pce.	CHF			19.90		19.90 3.73890210	

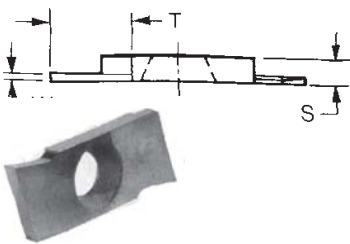

Ausführung : Standard rechts
Execution : Standard à droite
Execution : Standard right

373894..

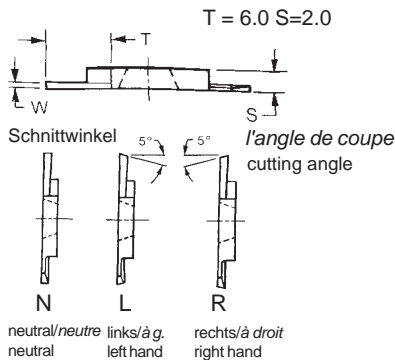

Platten zum EIN-und ABSTECHEIN *Plaquettes à RONCONNER et à RAINURER* Inserts for GROOVING and CUT-OFF turning

W [mm]	Halter porte outil holder	Platte plaquette insert	Hartmetallsorten/nuances/grades 3.7389429			
			unbesch./non revêtue/non coated		beschichtet/revêtue/coated	
			K10	P40	P40PV	P25PV
1.00	R	N	001	002	003	004
1.00	R	R	005	006	007	008
1.00	R	L	009	010	011	012
1.00	L	N	013	014	015	016
1.00	L	R	017	018	019	020
1.00	L	L	021	022	023	024
1.50	R	N	025	026	027	028
1.50	R	R	030	032	034	036
1.50	R	L	038	040	042	044
1.50	L	N	046	048	050	052
1.50	L	R	054	056	058	060
1.50	L	L	062	064	066	068
2.00	R	N	070	072	074	076
2.00	R	R	078	080	082	084
2.00	R	L	086	088	090	092
2.00	L	N	094	096	098	100
2.00	L	R	102	104	106	108
2.00	L	L	110	112	114	116
Preis/Stck./prix/price/pce.	CHF		19.90		19.90	

373892..

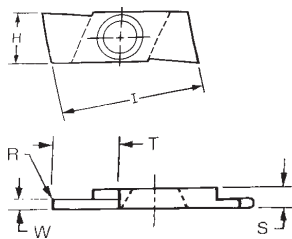

PLATTEN zum EINSTE-CHEN mit RADIUS *Plaquettes à RAINURER avec RAYON* Inserts for GROOVING with RADIUS

3.73892210	unbesch./non revêtue/no coating			besch./revêtue/coated		
Type/type	W[mm]	R[mm]	K10	P40	P25PV	P40PV
rechts/à dr./right	1.00	0.50	001	002	003	004
links/à g./left	1.00	0.50	005	006	007	008
rechts/à dr./right	1.50	0.75	009	010	011	012
links/à g./left	1.50	0.75	013	014	015	016
rechts/à dr./right	2.00	1.00	017	018	019	020
links/à g./left	2.00	1.00	021	022	023	024
Preis/Stck./prix/pce.	CHF			19.90		19.90

373896../ 98..

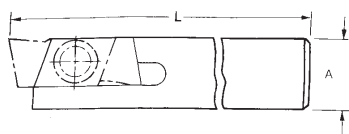

Platten Halter *Porte-outil* Insert holder

Typ type	Dimension dimension / dimensions					Best nr. no. Cde.	Preis prix / price
3.73896210	A	X	A	X	L	[mm] order no.	CHF
Standard rechts à droite/right	8	X	8	X	100	373896. 00	74.70
	10	X	10	X	120	373896. 05	74.70
	12	X	12	X	120	373896. 10	74.70
Standard links à gauche/left	8	X	8	X	100	373896. 01	74.70
	10	X	10	X	120	373896. 06	74.70
	12	X	12	X	120	373896. 11	74.70
Für Automatendrehbänke / pour tours automatiques / for turning automatics							
rechts à droite/right	8	X	8	X	140	373898. 00	107.10
	10	X	10	X	150	373898. 05	107.10
links à gauche/left	8	X	8	X	140	373898. 01	107.10
	10	X	10	X	150	373898. 06	107.10

NEW GRIP Ein-und Abstechsysteme

Ein bewährtes Programm mit neuen Ideen

- Einstech- und Abstechplatten
- Universalplattenhalter NGTHR/L, Schneidenträger NGIH-PS, Halter NGTBN..
- **unbeschichtet** für Guss und Stahl (N22 und N52), **beschichtet mit PV52** (AL-Oxyd-PVD-20µ) Grosser Einsatzbereich: P05-P50, K05-K20

Systèmes de tronçonnage et rain. NEW GRIP
Un progr. éprouvé, amélioré grâce à de nouv.idées

- *plaqu. à tronç. et à rainurer* - burins porte-pl. NGTHR/L., lame porte-pl. NGIH-PS, porte-outils NGTBN
- *non-revêtues p.travailler la fonte et l'acier (N22 et N52), revêtement PV52(AL-OXYD-20µ)* vaste gamme d'application: P05-P50, K05-K20

NEW GRIP cut-off and grooving system
a proven product program with new ideas

- *grooving and cut-off inserts* - Universal insert holder NGTHR/L, blades NGIH-PS, tool blocks NGTBN..
- **non coated inserts** for cast iron and steel (N22 &N52), coated with PV52 (AL-Oxyd-PVD-20µ) Broad application: P05-P50, K05-K20



NGTN.. 373805..

Ab-u.Einstecken-Platten Plaqu. tronçon.&rain. Inserts cut-off & grooving

Typ type	mit Beschicht./ revêtue/coated PV52			ohne Beschicht./non revêtue/non coated		
	cat.price Kat.-Preis prix cat.	action price Aktpreis prix d.act.	Best.Nr./no.cde. order no.	K10/N22 Best.Nr./no.cde. order no.	cat.price HIT price prix cat.	HIT price Best.Nr./no.cde. order no.
3.7380529	CHF	CHF			CHF	CHF
NGTN - 2	15.30	10.30	373805. 204	373805. 199	11.90	8.00 373805. 202
NGTN - 3	15.30	10.30	373805. 244	373805. 241	10.80	7.30 373805. 242
NGTN - 4	16.00	10.50	373805. 264	373805. 261	13.00	8.20 373805. 262



Platten-Halter

Burins porte-plaquettes Adjustable blades

Type	A		B		C		Inserts Ein- sätze Max. plaquet- diam. les	price cat. Katalog- preis prix cat.	HIT price Prix choc Hit-preis CHF	order no. Best.Nr. no.cde. NGTHR	order no. Best.Nr. no.cde. NGTHL	price cat. Katalog- preis prix cat.	mit /avec/ Hit-preis CHF	with /with Hit-preis CHF	Positive Stop Best.Nr. no.cde. NGTHR.PS	Positive Stop Best.Nr. no.cde. NGTHL.PS	
	B1	B2	C1	C2	CHF	CHF											CHF
NGTHR/L 10-2	9,5	10	86	19	5	18	28	101.00	60.60	200	200	119.20	71.50	200	200	373870..	373875..
NGTHR/L 10-3	9,5	10	86	19	5	18	30	101.70	60.60	210	210	119.20	71.50	210	210	373870..	373875..
NGTHR/L 12-2	10	12	110	19	18	30		101.70	60.60	220	220	119.20	71.50	220	220	373870..	373875..
NGTHR/L 12-3	10	12	110	21	6	21	32	101.70	60.60	240	240	119.20	71.50	240	240	373870..	373875..
NGTHR/L 16-2	10	16	110	19	--	18	30	116.90	70.10	260	260	123.50	74.10	260	260	373870..	373875..
NGTHR/L 16-3	12	16	110	24	4	20	32	116.90	70.10	280	280	123.50	74.10	280	280	373870..	373875..
NGTHR/L 16-4	12	16	110	24	4	21	34	116.90	70.10	300	300	123.50	74.10	300	300	373870..	373875..
NGTHR/L 19-2	12	19	110	24	20	32		125.80	75.50	310	310	135.40	74.10	310	310	373870..	373875..
NGTHR/L 19-3	12	19	110	24	21	34		125.80	75.50	312	312	135.40	74.10	312	312	373870..	373875..
NGTHR/L 19-4	12	19	110	24	23	36		125.80	75.50	314	314	135.40	74.10	314	314	373870..	373875..
NGTHR/L 20-2	12	20	110	24	--	20	32	125.80	75.50	320	320	135.40	74.10	320	320	373870..	373875..
NGTHR/L 20-3	12	20	110	24	--	21	36	125.80	75.50	340	340	135.40	74.10	340	340	373870..	373875..
NGTHR/L 20-4	12	20	110	24	--	23	39	125.80	75.50	360	360	135.40	74.10	360	360	373870..	373875..
NGTHR/L 20-5	12	20	110	24	--	23	39	125.80	75.50	380	380	135.40	74.10	380	380	373870..	373875..
NGTHR/L 25-3	25	25	150	30	--	25	36	151.90	91.15	400	400	178.10	106.85	400	400	373870..	373875..
NGTHR/L 25-4	25	25	150	30	--	30	39	151.90	91.15	420	420	178.10	106.85	420	420	373870..	373875..
NGTHR/L 25-5	25	25	150	30	--	34	39	151.90	91.15	440	440	178.10	106.85	440	440	373870..	373875..

NGTHR/L.. 373870..

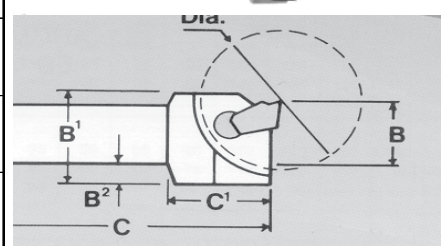

Klingen

Lames

Blades

Type	Breite largeur width		D MAX. mm	Platten plaquettes inserts				Kat.Preis Prix cat. price cat. CHF	HIT-Preis Prix choc HIT-price CHF	Best.Nr. no.cde order no. 373830..
	W	A		L	H	H1	NGTN/R/L..			
NGIH 19 - 2 - PS	2,2-2,4	40	1,6	86	15,5	19	2-2,4	123.50	86.30	200
NGIH 26 - 2 - PS	2,2-2,4	75	1,6	110	21	26	2-2,4	123.50	86.30	220
NGIH 26 - 3 - PS	3,1	75	2,4	110	21	26	3	123.50	86.30	240
NGIH 26 - 4 - PS	4,1	75	3,2	110	21	26	4	127.80	91.80	260
NGIH 26 - 5 - PS	4,8-5,1	75	4,0	110	21	26	4,8-5	139.90	100.60	280
NGIH 26 - 6 - PS	6,4	75	5,2	110	21	26	6	145.30	87.20	300
NGIH 32 - 3 - PS	3,1	100	2,4	150	25	32	3	127.80	91.80	320
NGIH 32 - 4 - PS	4,1	100	3,2	150	25	32	4	135.40	96.10	340
NGIH 32 - 5 - PS	4,8-5,1	127	4,0	150	25	32	4,8-5	132.20	95.00	360
NGIH 32 - 6 - PS	6,4	127	5,2	150	25	32	6	137.70	99.15	380
NGIH 32 - 8 - PS	8,0	140	6,8	150	25	32	8	180.30	129.80	400
NGIH 32 - 9 - PS	9,6	127	8,0	150	25	32	9	179.10	133.00	420

NGIH-PS 373830..

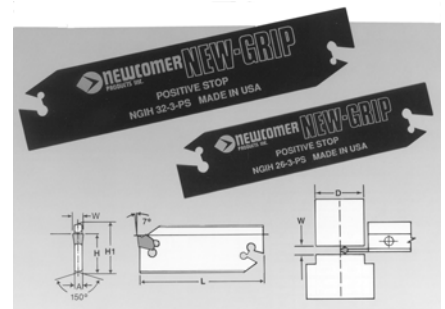

Halter für Klingen

Portes-outils p. lames Blade holders

Type	Hohe hauteur height	Breite largeur width			Klingen lames inserts NGIH..	Kat.Preis Prix cat. cat.price CHF	HIT-Preis Prix choc HIT-price CHF	Best.Nr. no.cde order no. 373850..	
		A	B	C					
NGTBN 16 - 2	16	16	87	30	26	19 - 2	197.80	113.30	200
NGTBN 16 - 5	16	16	87	38	33	26 - 2	203.20	116.30	220
NGTBN 19 - 5	19	19	87	38	37	26 - 3	208.70	119.20	240
NGTBN 20 - 5	20	20	87	38	37	26 - 4	208.70	119.20	260
NGTBN 25 - 5	25	20	87	38	37	26 - 5	216.30	123.50	280
NGTBN 19 - 6	19	19	110	45	37	32 - 3	213.10	120.60	300
NGTBN 20 - 6	20	19	110	45	37	32 - 4	213.10	120.60	320
NGTBN 25 - 6	25	20	110	48	37	32 - 5	218.60	124.90	340
NGTBN 32 - 6	32	28	110	48	46	32 - 6	227.20	129.40	360
NGTBN 32 - 1 - 6	32	28	110	48	49	32 - 8	320.40	178.10	380
NGTBN 38 - 6	38	41	110	48	62	32 - 9	345.40	197.70	400

NGTBN.. 373850..

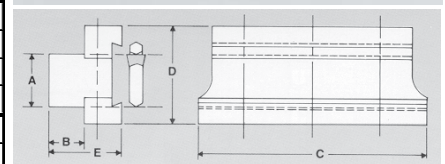



**SET MINI-SYSTEM Z.EIN-
STECHEN UNTER 2MM**

**KIT MINI-SYSTÈME À
RAINURER MINITHIN**

**SET MINI-SYSTEM for
GROOVING BELOW 2MM**

Bestehend aus:

- 1 Halter 12x12x120mm
3.73896.10
- 5 Schneidplatten beschich-
tet P25PV (1.85R-1.60R-
1.3R-1.1R-0.9R)
- 2 Schrauben M3x7.5
- 1 Schlüssel Torx T8

Composition:

- 1 Porte-outil 12x12x120
3.73896.10
- 5 plaquettes revêtues
P25PV (1.85R-1.60R-
1.3R-1.1R-0.9R)
- 2 vis M3 x 7.5
- 1 clé Torx T 8

Composed of:

- 1 holder 12x12x120mm
order no. 3.73896.10
- 5 inserts coated P25PV
(1.85R-1.60R-1.3R-1.1R-
0.9R)
- 2 screws M3x7.5
- 1 key Torx T8

Bestell-Nr./no.cde./order no. 373893.10

174.10

NEWCOMER

**NEW GRIP Ein- & Ab-
stechsystem in SÄTZEN
zu AKTIONSPREISEN**

**Systèmes de tronçon-
nage & rainurage NEW
GRIP EN JEUX AU**

**Sets of NEW GRIP Cut-
ting & grooving systems
at action prices**



1 GTHR-16-3 Starter KIT

Bestell-Nr./no.cde. order no. 373862.25

130.10

bestehend aus/composition/composed of:

- 1 Universalhalter/porte-outil universel/ universal holder **GTHR-16-3**
- 10 Schneidplatten/plaquettes/inserts **NGTN-3-PV 52**
- 1 Montageschlüssel/clé de montage/ assembly key **NEW GRIP**



1 NEW-GRIP Starter KIT Nr. 4

Bestell-Nr./no.cde. 373862.10

259.80

bestehend aus/composition/composed of:

- 1 Halter/porte-outil block **GTBN 16-5**
- 1 Schneidenträger/porte-plaquettes/insert holder **26-3-PS**
(Positive STOP)
- 10 Schneidplatten/plaquettes/inserts **NGTN-3-PV 52**
- 1 Montageschlüssel/clé de montage/assembly key **New GRIP**
- 1 Imbusschlüssel/clé imbus/hexagonal key 5mm



1 NEW-GRIP Starter KIT Nr. 6

Bestell-Nr./no.cde. 373862.20

298.-

bestehend aus/composition/composed of:

- 1 Halter/porte-outil block **GTBN 20-6mm**
- 1 Schneidenträger/porte-plaquettes/insert holder **GIH-32-3-PS**
(Positive STOP)
- 10 Schneidplatten/plaquettes/inserts **NGTN-3-PV 52**
- 1 Montageschlüssel/clé de montage/assemble key **New GRIP**
- 1 Imbusschlüssel/clé imbus/hexagonal key 5mm