

Innendrehstähe IFANGER *Burins p. tournage intéri-* **Internal turning chisel**
Ausbohrstahl ASB *eur type ASB de IFANGER* **IFANGER typ ASB**

- Winkel 40 °
- HSS-Co, rechtsschneidend
- in TiN-Beschichtung und Hartmetallausführung K10, P10 und P30 auf Anfrage
- angle 40 °
- qualité HSS-Co, coupe à droite
- en revêtement TiN et carbure monobloc K10, P10 et P30 sur demande
- Angle 40 °
- HSS-Co, righ hand cutting
- available also in TiN-coating, carbide, grade K10, P10 and P30 on request

Grösse dimension dimensions	B	H	S-h7	L1	L2	Best.Nr. no.de cde. order no.	3.747ASBRNK29 CHF
0000	3.5	2	8	20	45	3747ASB. 070	20.30
000	4	2.5	8	23	49	3747ASB. 130	20.30
00	5	3	8	25	52	3747ASB. 190	20.30
0	6.5	4	8	29	56	3747ASB. 250	20.30
0/1	8.5	5	8	31	60	3747ASB. 310	21.90
1	10	6	8	33	65	3747ASB. 370	24.10
2	13	8	8	..	72	3747ASB. 410	28.80

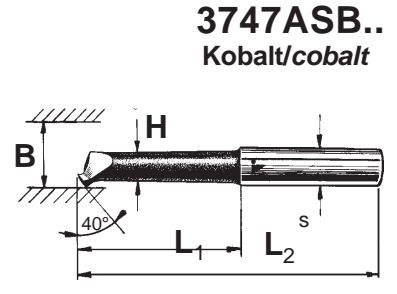

Grösse dimension dimensions	B	H	S-h7	L1	L2	Best.Nr. no.de cde. order no.	3.747ASBRCK29 CHF
0000	3.5	2	8	9	35	3747ASB. 050	17.80
000	4	2.5	8	11	38	3747ASB. 110	17.80
00	5	3	8	13	40	3747ASB. 170	17.80
0	6.5	4	8	16	44	3747ASB. 230	17.80
0/1	8.5	5	8	19	48	3747ASB. 290	19.30
1	10	6	8	23	53	3747ASB. 350	21.10

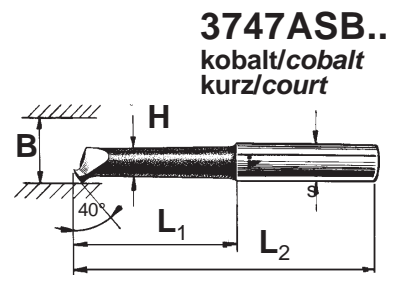

Grösse dimension dimensions	B	H	S-h7	L1	L2	Best.Nr. no.de cde. order no.	3.747ASBRBK29 CHF
0000	3.5	2	8	25	52	3747ASB. 090	24.20
000	4	2.5	8	28	58	3747ASB. 150	24.20
00	5	3	8	32	64	3747ASB. 210	24.20
0	6.5	4	8	35	69	3747ASB. 270	24.20
0/1	8.5	5	8	38	75	3747ASB. 330	26.30
1	10	6	8	41	82	3747ASB. 390	28.60
2	13	8	8	..	100	3747ASB. 430	34.90

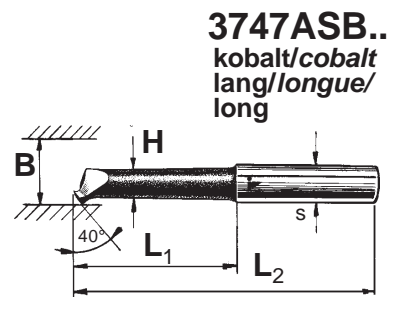

Schneidköpfe ASB **Tête de rechange ASB** **Cutting heads ASB**

- aufschraubbar, Schäfte siehe 3.747SCH
- in HSS-Co, rechtsschneidend in TiN-Beschichtung, HM K10, P10 und P30 auf Anfrage
- à visser, tiges voir 3.747SCH
- en HSS-Co, coupe à droite
- en revêtement TiN, carbure monobloc K10, P10 et P30 sur demande
- to unscrew, for shanks consult 3.747SCH
- in HSS-Co, right hand cut
- TiN-coating, carbide K10, P10 and P30 on request

Grösse dimension dimensions	B	H	S-h11	Schaftgewinde filrage tige thread on shank	L*	Best.Nr. no.de cde. order no.	3.747ASBKK29 CHF
3	17	10	10	M6	100	3747ASB. 450	26.00
4	21	12	13	M8	230	3747ASB. 470	32.50
5	24	14	15	M10x20G"	260	3747ASB. 490	40.00
6	28	16.3	17	M12x20G"	280	3747ASB. 510	49.70
7	31	18.3	19	M14x20G"	310	3747ASB. 530	59.70
8	34	20	20	M15x20G"	330	3747ASB. 550	72.60
9	37	22	22	M15x20G"	380	3747ASB. 570	92.40
10	42	25	25	M18x20G"	390	3747ASB. 590	119.50
11	50	30	30	M21x14G"	430	3747ASB. 610	160.00
12	60	35	35	M25x14G"	380	3747ASB. 630	206.50

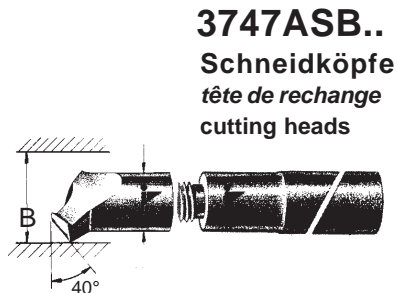

3.747ASBKK29 * Totallänge inklusive Schaft/langueur totale tige inclusive/total length incl. shank

Innendrehstähle IFAN-GER Eckstahl ECS

- Winkel 90 °
- HSS-Co, rechtsschneidend
- in TiN-Beschichtung und Hartmetall-ausführung K10 und P30 auf Anfrage

Burins p. tournage inté- Internal turning chisel eur type ECS de IFANGER IFANGER typ ECS

- angle 90 °
- qualité HSS-Co, coupe à droite
- en revêtement TiN et carbure monobloc K10 et P30 sur demande
- Angle 90 °
- HSS-Co, right hand cut
- in TiN-coating and carbide execution K10 & P30 on request

3747ECS.. Kobalt/cobalt medium/normale medium

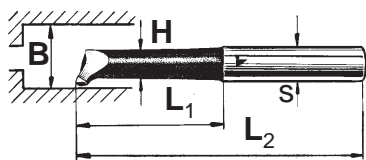

Grösse dimension dimensions	B	H	S-h7	L1	L2	Best.Nr. no.de cde. order no.	3.747ECSRNK29 CHF
0000	3.5	2	8	20	45	3747ECS. 070	24.10
000	4	2.5	8	23	49	3747ECS. 130	24.10
00	5	3	8	25	52	3747ECS. 190	24.10
0	6.5	4	8	29	56	3747ECS. 250	24.10
0/1	8.5	5	8	31	60	3747ECS. 310	25.90
1	10	6	8	33	65	3747ECS. 370	28.00
2	13	8	8	..	72	3747ECS. 410	33.30

3747ECS.. kobalt/cobalt kurz/courte/short

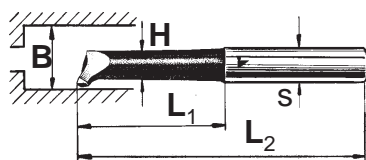

Grösse dimension dimensions	B	H	S-h7	L1	L2	Best.Nr. no.de cde. order no.	3.747ECSRCK29 CHF
0000	3.5	2	8	9	35	3747ECS. 050	24.10
000	4	2.5	8	11	38	3747ECS. 110	24.10
00	5	3	8	13	40	3747ECS. 170	24.10
0	6.5	4	8	16	44	3747ECS. 230	24.10
0/1	8.5	5	8	19	48	3747ECS. 290	25.90
1	10	6	8	23	53	3747ECS. 350	28.00

3747ECS.. kobalt/cobalt lang/longue/long

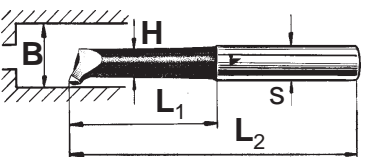

Grösse dimension dimensions	B	H	S-h7	L1	L2	Best.Nr. no.de cde. order no.	3.747ECSRTK29 CHF
0000	3.5	2	8	25	52	3747ECS. 090	28.40
000	4	2.5	8	28	58	3747ECS. 150	28.40
00	5	3	8	32	64	3747ECS. 210	28.40
0	6.5	4	8	35	69	3747ECS. 270	28.40
0/1	8.5	5	8	38	75	3747ECS. 330	30.00
1	10	6	8	41	82	3747ECS. 390	32.50
2	13	8	8	..	100	3747ECS. 430	39.10

Schneidköpfe ECS

- aufschraubbar, Schäfte siehe 3.747SCH
- in HSS-Co, rechtsschneidend
- in TiN-Beschichtung, HM K10, P10 und P30 auf Anfrage

Tête de rechange ECS

- à visser, tiges voir 3.747SCH
- en HSS-Co, coupe à droite
- en revêtement TiN, carbure monobloc K10, P10 et P30 sur demande

Cutting heads ECS

- to unscrew, for shanks consult 3.747SCH
- in HSS-Co, right hand cut
- TiN-coating, carbide K10, P10 and P30 on request

3747ECS.. Schneidköpfe têtes de rechange cutting heads

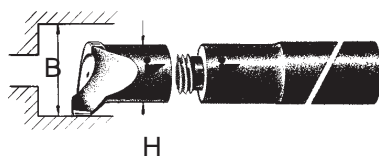

Grösse dimension dimensions	B	H	Schaftgewinde filitage tige thread on shank	L*	Best.Nr. no.de cde. order no.	3.747ECSKK29 CHF
3	17	10	M6	100	3747ECS. 450	30.90
4	21	12	M8	230	3747ECS. 470	38.30
5	24	14	M10x20G/"	260	3747ECS. 490	47.80
6	28	16.3	M12x20G/"	280	3747ECS. 510	58.00
7	31	18.3	M14x20G/"	310	3747ECS. 530	68.80
8	34	20	M15x20G/"	330	3747ECS. 550	82.10
9	37	22	M15x20G/"	280	3747ECS. 570	103.30
10	42	25	M18x20G/"	390	3747ECS. 590	136.40
11	50	30	M21x14G/"	430	3747ECS. 610	179.90
12	60	35	M25x14G/"	280	3747ECS. 630	238.30

* Totallänge inklusive Schaft/longueur totale tige inclusive/total length incl. shank

Innendrehstähle IFANGER *Burins p.tourn.intér. IFAN-* Intern.turning IFANGER
Schäfte für ASB und ECS *GER, tiges p. ASB et ECS* shanks for ASB & ECS

3747SCH..

- normal und vertärkt* für Hartmetallköpfe
- Gewinde der Schäfte und aufschraubbaren Köpfe beachten
- *standard et renforcées* pour têtes à visser métal dur*
- *observez le filetage des tiges et têtes*
- standard & reinforced* for carbide heads
- observe the threads on the shanks

Grösse dimension dimensions	S-h11	Schaftgewinde filetage tige thread on shank	L*	Best.Nr. no.de cde. order no.	3.747SCH29 CHF
3	10	M6	100	3747SCH. 050	7.40
3	10	M6	125	3747SCH. 090	8.70
3	12	M6	200	3747SCH. 130	12.30
4	13	M6	230	3747SCH. 170	13.10
4*	14	M8	230	3747SCH. 210	15.80
5	15	M10x20G/"	260	3747SCH. 250	16.90
5*	16	M10x20G/"	260	3747SCH. 290	19.30
6	17	M12x20G/"	280	3747SCH. 330	21.00
6*	18	M12x20G/"	280	3747SCH. 370	24.10
7	19	M14x20G/"	310	3747SCH. 410	32.70
7*	20	M14x20G/"	310	3747SCH. 450	29.30
8	20	M15x20G/"	330	3747SCH. 490	29.30
8*	22	M15x20G/"	330	3747SCH. 530	37.40
9	22	M15x20G/"	360	3747SCH. 570	37.40
9*	25	M15x20G/"	360	3747SCH. 610	45.20
10	25	M18x20G/"	390	3747SCH. 650	47.10
10*	30	M18x20G/"	390	3747SCH. 690	61.70
11	30	M21x20G/"	430	3747SCH. 730	61.70
11*	35	M21x14G/"	430	3747SCH. 770	80.50
12	35	M25x14G/"	500	3747SCH. 810	87.80

* verstäkt für HM-Schneidköpfe/renforcée pour têtes en métal dur/reinforced for cutting heads from carbide

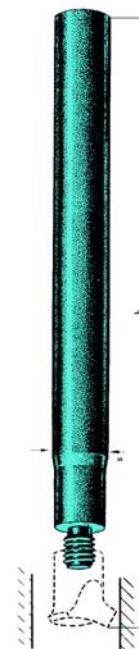

Aussendrehstähle IFANGER *Outils de tournage extér.* External turning chisel
GER Stahlhalter AH & BH *IFANGER p.-out.AH et BH* IFANGER holder AH & BH

3743..
AH + BH

Grösse dimension dimensions	Grösse Messer size blade Dimension lame	Spitzenhöhe- hight to centers hauteur H B L		AH ISO 30° rechts/à droite/right AH ISO 30° Best.Nr./no.cde./order no.		BH ISO 30° links/à gauche/left BH ISO 30° Best.Nr./no.cde./order no.		CHF
		H	B	L	Best.Nr./no.cde./order no.	Best.Nr./no.cde./order no.	CHF	
1/12	1	12	10	10	120	3743. 010	3743. 020	71.90
1	1	16-12	14	13	120	3743. 090	3743. 120	58.90
2	2	20-16	18	16	140	3743. 230	3743. 260	67.40
3	3	25-20	23	19	160	3743. 390	3743. 420	78.00
4	4	30-25	28	22	180	3743. 530	3743. 560	90.90

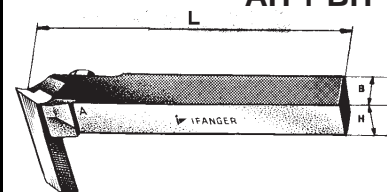

Kobalt-Messer A zu Halter *lame cobalt A pour porte-* Blade A from cobalt for
AH rechts *lames AH à droite* holder AH right hand

3743..
kobalt/cobalt
à droite/right

Grösse/size	1	2	3	4	dimension
Länge/length	40	50	60	70	longueur
Best.Nr./order no.	3743. 070	3743. 210	3743. 370	3743. 510	no.de cde.
CHF	23.00	28.80	38.70	49.30	CHF

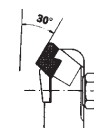

Typ A (rechts)

Kobalt-Messer B zu Halter *lames cobalt B p. porte-* Blade B from cobalt for
BH links *lames BH à gauche* holder BH left hand

3743..
kobalt/cobalt
à gauche/left

Grösse/size	1	2	3	4	dimension
Länge/length	40	50	60	70	longueur
Best.Nr./order no.	3743. 100	3743. 240	3743. 400	3743. 540	no.de cde.
CHF	23.00	28.80	38.70	49.30	CHF



Typ B (links)

Stahlhalter DH und EH *porte-outils DH et EH* Blade Holder DH & EH

3743..
DH + EH

Grösse dimension size	Grösse Messer Size blade Dimension lame	Spitzenhöhe hight to centers hauteur H B L		DH ISO rechts/à droite right CHF		EH ISO links/à gauche left CHF		
		H	B	L	Best.Nr./no.cde./order no.	Best.Nr./no.cde./order no.	CHF	
1/12	1	12	10	10	120	3743. 030	3743. 040	71.90
1	1	16-12	14	13	120	3743. 140	3743. 160	58.90
2	2	20-16	18	16	140	3743. 280	3743. 300	67.40
3	3	25-20	23	19	160	3743. 440	3743. 460	78.00
4	4	30-25	28	22	180	3743. 580	3743. 600	96.70

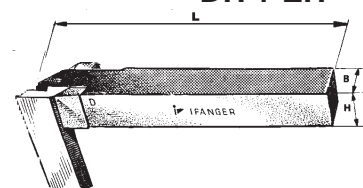

3743.. D
Kobalt/cobalt

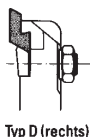

Typ D (rechts)

Messer D rechts zu Halter *lames D à dr. pour porte-* Blade D right for holder
DH *lames DH* DH

Grösse/size	1	2	3	4	5	dimension	3.743D29
Länge/length	40	50	60	70	80	longueur	
Best.Nr./order no.	3743. 130	3743. 270	3743. 430	3743. 570	3743. 700	no.de cde.	
CHF	24.10	32.30	42.20	54.30	68.30	CHF	

3743.. E
Kobalt/cobalt

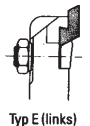

Typ E (links)

Messer E links z.Halter EH *lames E à g. pour p.-la.EH* Blade E left for holder EH

Grösse/size	1	2	3	4	5	dimension	3.743E29
Länge/length	40	50	60	70	80	longueur	
Best.Nr./order no.	3743. 150	3743. 290	3743. 450	3743. 590	3743. 720	no.de cde.	
Fr.	24.10	32.30	42.20	54.30	68.30	Fr.	

3743.. XH/YH

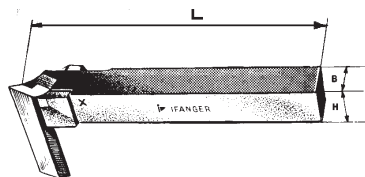

Halbschräge Schruppstäh- *Porte-outils XH à dr.et YH* Semi oblique roughing-
le XH rechts und YH links *à g. p.lames d'ébau.coudé* holder XH right & YH left

3.743XH29	Grösse Me Spitzenhöhe	XH 13°			YH 13°		CHF
Grösse	Size blade height to centers	rechts/à droite			links/à gauche		
dimension	Dimension hauteur H B L	right			left		
size	lame hauteur H B L	Best.Nr./no.cde./order no.			Best.Nr./no.cde./order no.		
1/12	1 12	10	10	120	3743. 050	3743. 060	71.90
1	1 16-12	14	13	120	3743. 180	3743. 200	58.90
2	2 20-16	18	16	140	3743. 340	3743. 360	67.40
3	3 25-20	23	19	160	3743. 480	3743. 500	78.00
4	4 30-25	28	22	180	3743. 630	3743. 650	96.70
5	5 36-30	34	28	200	3743. 750	3743. 770	121.70

3743.. X
Kobalt/cobalt

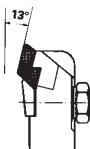

Typ X (rechts)

Messer X rechts zu Halter *lames X à dr. pour porte-* Blade X right for holder
XH *lames XH* XH

Grösse/size	1	2	3	4	5	dimension	3.743X29
Länge/length	40	50	60	70	80	longueur	
Best.Nr./order no.	3743. 170	3743. 330	3743. 470	3743. 620	3743. 740	no.de cde.	
CHF	24.10	32.30	42.20	54.30	68.30	CHF	

3743.. Y
Kobalt/cobalt

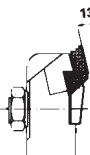

Messer Y links zu Halter *lames Y à g. pour porte-* Blade Y left for holder YH
YH *lames YH*

Grösse/size	1	2	3	4	5	dimension	3.743Y29
Länge/length	40	50	60	70	80	longueur	
Best.Nr./order no.	3743. 190	3743. 350	3743. 490	3743. 640	3743. 760	no.de cde.	
CHF	24.10	32.30	42.20	54.30	68.30	CHF	

3744.. FH/GH

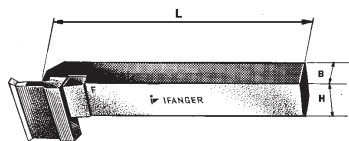

Typ F (rechts)

Typ G (links)

Abstechhalter IFANGER *Porte-outils FH à dr.et GH* Cut-of holder IFANGER
FH rechts und GH links *à g.à tronçon.de IFANGER* FH right & GH left

3.744FH29	Grösse Messr Spitzenhöhe	FH ISO			GH ISO		CHF
Grösse	Size blade height to centers	rechts/à droite			links/à gauche		
dimension	Dimension hauteur H B L	right			left		
size	lame hauteur H B L	Best.Nr./no.cde./order no.			Best.Nr./no.cde./order no.		
1/12	1 12	12	10	110	3744. 010	3744. 030	71.90
1	1 16-12	16	12	110	3744. 090	3744. 150	58.90
2	2 20-16	20	15	140	3744. 230	3744. 430	67.40
3	3 25-20	25	18	160	3744. 510	3744. 590	78.00
4	4 30-25	30	21	180	3744. 670	3744. 730	96.70
5	5 36-30	36	25	200	3744. 810	3744. 870	121.70

3744.. FN/FT
Kobalt/cobalt

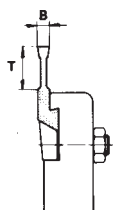

Typ F (rechts)

Messer rechts z. Halter FH *lames à dr. pour porte-* Blade right for holder FH
lames FH

3.744FN29	Länge Messer	Breite	Tiefe/prof./depth	Tiefe / prof./depth	FN	FT
Grösse	length of blade	largeur	normal	extra tief/special deep	Tiefe/depth normal	extra tief/special deep
dimension	longueur	width normale	extra grande	prof. normale	CHF	prof. ext. grande CHF
dimensions	lame	B +0/-0.5	T	T	Best.Nr./no.cde./order no	Best.Nr./no.cde./order no
1	25	3	11	16	3744. 050 22.70	3744. 070 28.80
2	32	3.5	14	19	3744. 190 30.00	3744. 210 37.30
3	41	4	17	24	3744. 470 38.60	3744. 490 48.50
4	50	4.5	23.5	33.5	3744. 630 50.90	3744. 650 65.00
5	60	5.5	30	40	3744. 770 95.70	3744. 790 81.20

Messer links zu Halter GH / lames à g. p. porte-lames GH / Blades left for holder GH

3.744GN29	Länge Msrer	Breite	Tiefe/prof.	Tiefe / prof./depth	GN		GT	
Grösse	longueur	largeur	normal	extra tief/deep	normal	tief/deep	extra tief/deep	
dimension	lame	width	normale	extra grande	prof. normale	CHF	prof. ext. grande	CHF
dimensions	blade length	+0/-0.5	T	T	Best.Nr./no.cde./order no.		Best.Nr./no.cde./order no.	
1	25	3	11	16	3744. 110	25.90	3744. 130	28.80
2	32	3.5	14	19	3744. 390	34.10	3744. 410	37.30
3	41	4	17	24	3744. 550	44.00	3744. 570	48.50
4	50	4.5	23.5	33.5	3744. 690	58.00	3744. 710	65.00
5	60	5.5	30	40	3744. 830	73.00	3744. 850	81.20

3744.. GN/GT
Kobalt/cobalt

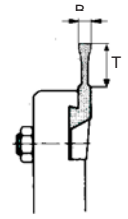

Typ G (links)

Abstechstahlhalter GHS / Porte-lames GHS / Cut-of holder GHS
für schwierige Verhältnisse / p. des conditions difficiles / for difficult conditions
(alte Drehbänke mit Lager- / (tours vieux avec trop de jeux / (old turning lathes with back-
spiel) für Messer GN / dansles roulements) pour des / lash) for blade GN
lames GN

3.744GHS29	Grösse Messer	Spitzenhöhe	GHS			CHF	
Grösse	Size blade	hight to centers	rechts/à droite				
dimension	Dimension	hauteur	H	B	L	right	
size	lame	pointe				Best.Nr./no.cde./order no.	
1	1	13-12	16	12	120	3744. 170	92.70
2	2	15-14	20	15	140	3744. 450	107.20
3	3	17-16	25	18	160	3744. 610	130.10
4	4	19-18	30	21	180	3744. 750	157.60

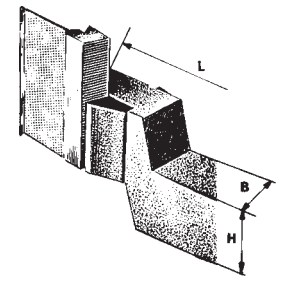

3744.. GHS

Seegerringnutmesser FSE / Lames cobalt FSE p. an- / Blade FSE for Seeger
für Seegerringeinstiche / neaux circlips Seeger / ring slots
nach DIN 472 zu verenden / Selon DIN 472 appli- / according DIN 472 applicable
mit Halter FH / quer avec porte-lames FH / with holder FH

Ringbreite	Für Nutenbreite	FSE Grösse/size 1	FSE Grösse/size 2	FSE Grösse/size 3	FSE Grösse/size 4	3.744FSE29			
largeur d'anneau	plageur d rainures	rechts/à droite/right	rechts/à droite/right	rechts/à droite/right	rechts/à droite/right				
with of rings	for width of slots	FSE Dimension 1	CHF FSE Dimension 2	CHF FSE Dimension 3	CHF FSE Dimension 4				
B1	B2-H13	Best.Nr./no.cde./order no.	Best.Nr./no.cde./order no.	Best.Nr./no.cde./order no.	Best.Nr./no.cde./order no.				
0.8	0.9	3744. 240	28.40	3744. 250	28.40	3744. 372	34.10	3744. 380	44.00
1	1.1	3744. 241	28.40	3744. 270	28.40	3744. 373	34.10	3744. 381	44.00
1.2	1.3	3744. 242	28.40	3744. 290	28.40	3744. 374	34.10	3744. 382	44.00
1.5	1.6	3744. 243	28.40	3744. 310	28.40	3744. 375	34.10	3744. 383	44.00
1.75	1.85	3744. 244	28.40	3744. 330	28.40	3744. 376	34.10	3744. 384	44.00
2	2.15	3744. 245	28.40	3744. 350	28.40	3744. 377	34.10	3744. 385	44.00
2.5	2.65			3744. 370	28.40	3744. 378	34.10	3744. 386	44.00
3	3.15					3744. 379	34.10	3744. 387	44.00
4	4.15							3744. 388	44.00

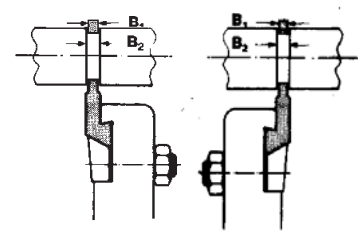

Halter Typ F
Messer Typ FSE
(rechts)
à droite/right

Halter Typ G
Messer Typ GSE
(links)
à gauche/left

Messer GSE(links) sowie andere Schneidstoffe auf Anfrage / lame GSE(à gauche) et d'autres nuances sur demande / Blades GSE(left) as well as other cutting materials on request

Gewindestähle K und L / Porte-lames p. fileter K et L / Screw plate K and L

3.745KH29	Grösse Messer	Spitzenhöhe	KH 55/60 °			LH 55/60 °		CHF
Grösse	Dimension	hight to centers	rechts/à droite/right			links/à gauche/left		
dimension	lame	hauteur	H	B	L	Best.Nr./no.cde..	Best.Nr./no.cde..	
dimensions	size blades	pointe				order no.	order no.	
0	0/1	13-10	16	12	100	3745. 050	3745. 060	98.90
1	0/1	17-14	18	15	110	3745. 200	3745. 220	107.20
2	2	22-18	20	18	140	3745. 350	3745. 360	120.00
3	3	27-23	25	22	160	3745. 550	3745. 560	142.50
4	4	33-28	32	25	180	3745. 700	3745. 720	184.70
5	5	37-34	36	28	200	3745. 750	3745. 760	231.10

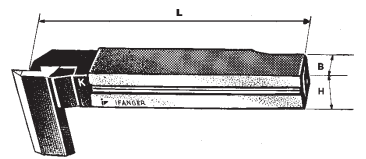

3745.. KH & LH

Messer 55/60 ° normal / Lames 55/60 ° largeur / Blades 55/60 ° normal
breit, max. Steigung = / normale, pas maximal = / width, pitch = width of
Messerbreite / largeur / blade

Gewinde	Grösse	0/1	2	3	4	5	dimension/size
Thread	Länge	40	50	60	70	80	longueur/length
filetage	max. Steigung	2.5	3	3.5	4.5	5.5	pas max./max. pitch
55 °	Best.Nr.	3745. 100	3745. 250	3745. 450	3745. 600	3745. 760	no.de cde. order no.
	CHF	25.20	32.60	42.00	54.30	67.10	CHF
60 °	Best.Nr.	3745. 150	3745. 300	3745. 500	3745. 650	3745. 770	no.de cde. order no.
	CHF	25.20	32.60	42.00	54.30	67.10	Fr. 3.745K6029

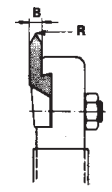

Typ K (rechts)
à droite/right

3745.. K60/55

Messer L links auf Anfrage / lames L à gauche sur demande / left blades on request